

General Purpose Transistors

NPN Silicon

- We declare that the material of product compliance with RoHS requirements.

ORDERING INFORMATION

Device	Marking	Shipping
L2SC2412KQMT1G	BQ	3000 Tape & Reel
L2SC2412KQMT3G	BQ	10000 Tape & Reel
L2SC2412KRMT1G	BR	3000 Tape & Reel
L2SC2412KRMT3G	BR	10000 Tape & Reel
L2SC2412KSMT1G	G 1F	3000 Tape & Reel
L2SC2412KSMT3G	G 1F	10000 Tape & Reel

L2SC2412KQMT1G Series

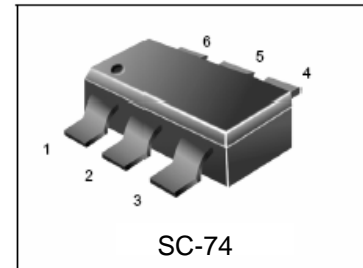

MAXIMUM RATINGS

Rating	Symbol	Value	Unit
Collector–Emitter Voltage	V_{CEO}	50	V
Collector–Base Voltage	V_{CBO}	60	V
Emitter–Base Voltage	V_{EBO}	7.0	V
Collector Current — Continuous	I_C	150	mAdc
Collector power dissipation	P_C	0.2	W
Junction temperature	T_j	150	°C
Storage temperature	T_{stg}	-55 ~ +150	°C

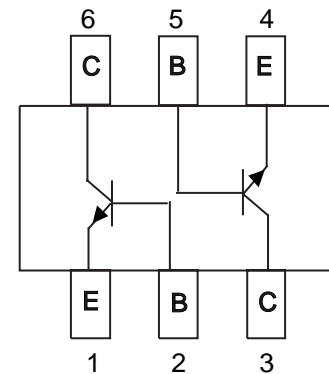

DEVICE MARKING

L2SC2412KQMT1G =BQ L2SC2412KRMT1G =BR L2SC2412KSMT1G =G1F

ELECTRICAL CHARACTERISTICS ($T_A = 25^\circ\text{C}$ unless otherwise noted.)

Characteristic	Symbol	Min	Typ	Max	Unit
Collector–Emitter Breakdown Voltage ($I_C = 1\text{ mA}$)	$V_{(BR)CEO}$	50	—	—	V
Emitter–Base Breakdown Voltage ($I_E = 50\ \mu\text{A}$)	$V_{(BR)EBO}$	7	—	—	V
Collector–Base Breakdown Voltage ($I_C = 50\ \mu\text{A}$)	$V_{(BR)CBO}$	60	—	—	V
Collector Cutoff Current ($V_{CB} = 60\text{ V}$)	I_{CBO}	—	—	0.1	μA
Emitter cutoff current ($V_{EB} = 7\text{ V}$)	I_{EBO}	—	—	0.1	μA
Collector-emitter saturation voltage ($I_C / I_B = 50\text{ mA} / 5\text{ mA}$)	$V_{CE(sat)}$	—	—	0.4	V
DC current transfer ratio ($V_{CE} = 6\text{ V}, I_C = 1\text{ mA}$)	h_{FE}	120	—	560	—
Transition frequency ($V_{CE} = 12\text{ V}, I_E = -2\text{ mA}, f = 30\text{ MHz}$)	f_T	—	180	—	MHz
Output capacitance ($V_{CB} = 12\text{ V}, I_E = 0\text{ A}, f = 1\text{ MHz}$)	C_{ob}	—	2.0	3.5	pF

h_{FE} values are classified as follows:

*	Q	R	S
h_{FE}	120~270	180~390	270~560

L2SC2412KQMT1G Series

Fig.1 Grounded emitter propagation characteristics

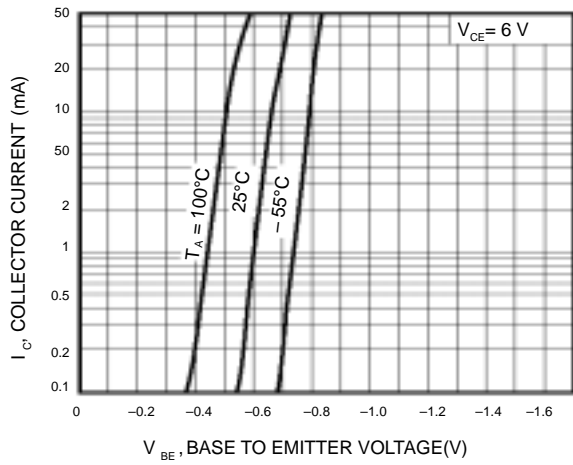

Fig.2 Grounded emitter output characteristics(I)

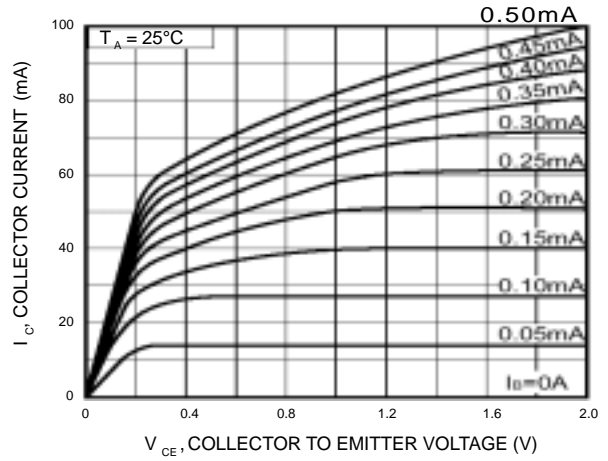

Fig.3 Grounded emitter output characteristics(II)

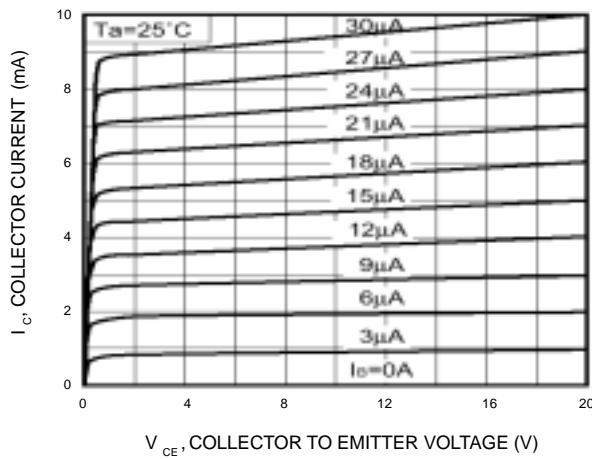

Fig.4 DC current gain vs. collector current (I)

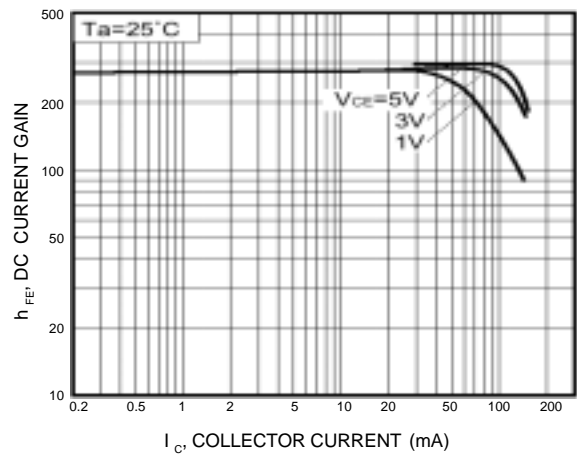

Fig.5 DC current gain vs. collector current (II)

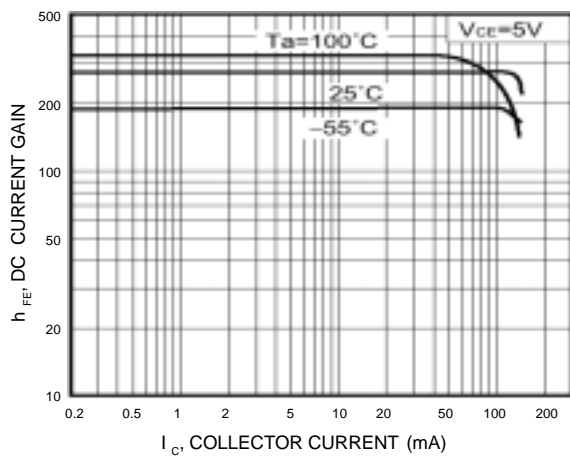
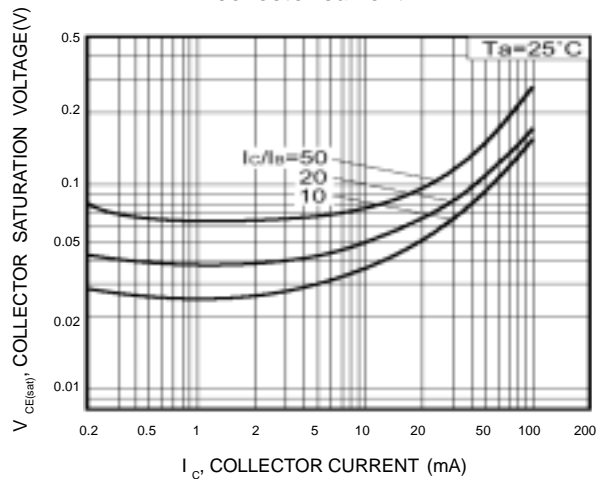

Fig.6 Collector-emitter saturation voltage vs. collector current



L2SC2412KQMT1G Series

Fig.7 Collector-emitter saturation voltage vs. collector current (I)

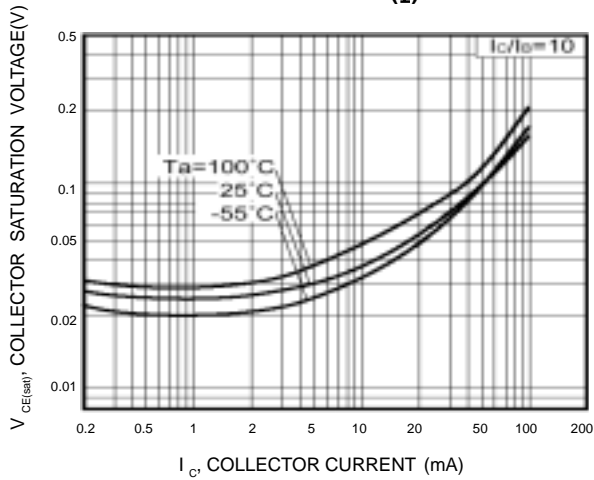

Fig.8 Collector-emitter saturation voltage vs. collector current (II)

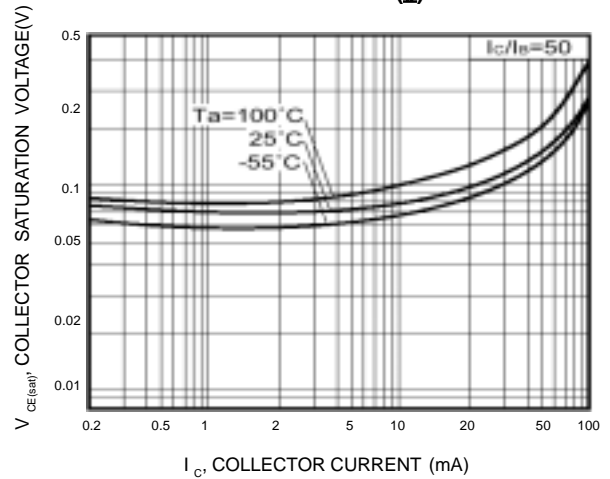

Fig.9 Gain bandwidth product vs. emitter current

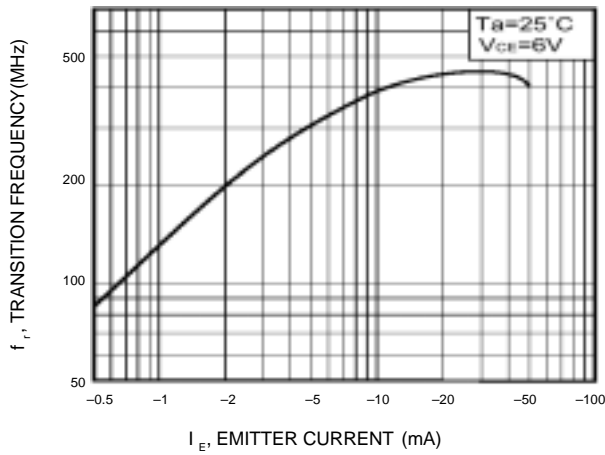

Fig.10 Collector output capacitance vs. collector-base voltage
Emitter input capacitance vs. emitter-base voltage

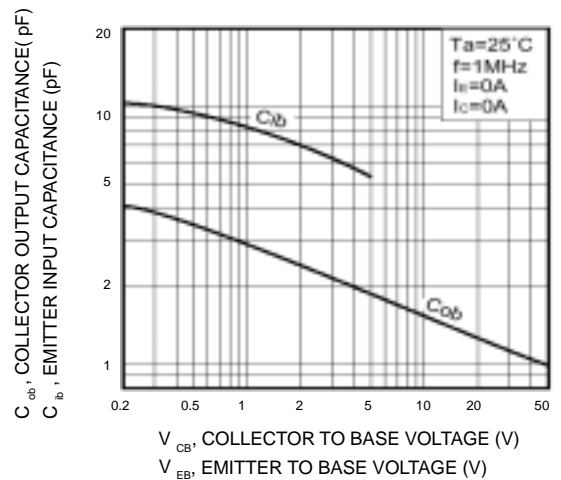
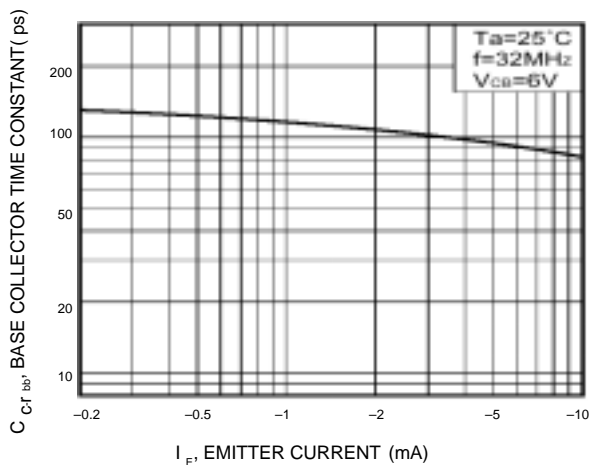
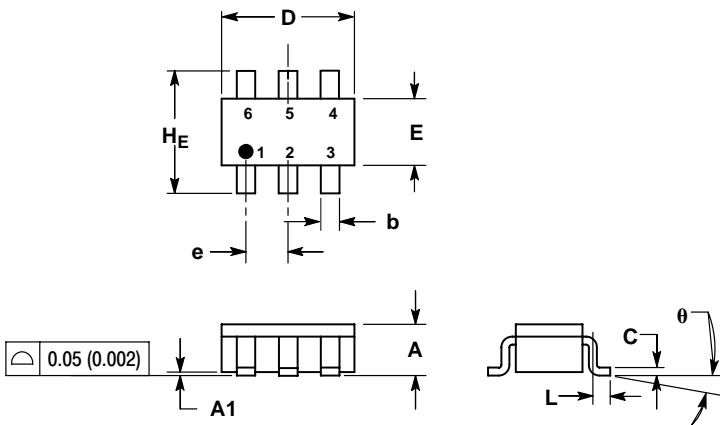

Fig.11 Base-collector time constant vs. emitter current



L2SC2412KQMT1G
Series

SC-74



DIM	MILLIMETERS			INCHES		
	MIN	NOM	MAX	MIN	NOM	MAX
A	0.90	1.00	1.10	0.035	0.039	0.043
A1	0.01	0.06	0.10	0.001	0.002	0.004
b	0.25	0.37	0.50	0.010	0.015	0.020
c	0.10	0.18	0.26	0.004	0.007	0.010
D	2.90	3.00	3.10	0.114	0.118	0.122
E	1.30	1.50	1.70	0.051	0.059	0.067
e	0.85	0.95	1.05	0.034	0.037	0.041
L	0.20	0.40	0.60	0.008	0.016	0.024
HE	2.50	2.75	3.00	0.099	0.108	0.118
theta	0°	-	10°	0°	-	10°